

Self-Supporting Capacity Diagram

The maximum length of the self-supporting capacity ($\frac{LS}{2}$) in relationship to the weight of the cables and hoses contained per linear metre.

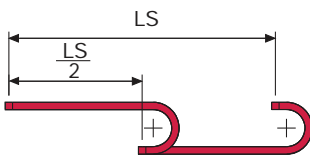
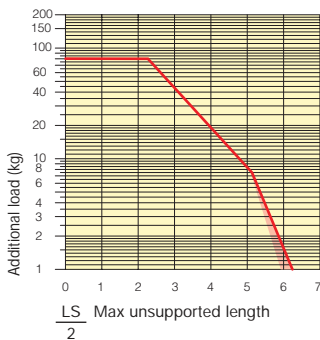

The red marking in the diagram area considers the difference of weight between various widths of chains assembled with aluminium draw plates every second pitch.

For applications with $\frac{LS}{2}$ and weights not included in the area of the diagram showing self-supporting capacity, verify the possible use of support rollers (see page 30).

Bright Zinc Plated Steel End Brackets

The end brackets set, containing four steel plates screwed to the links allows the two ends of the chain to be attached to the equipment.

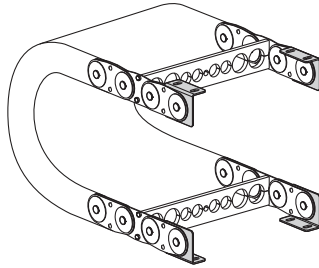
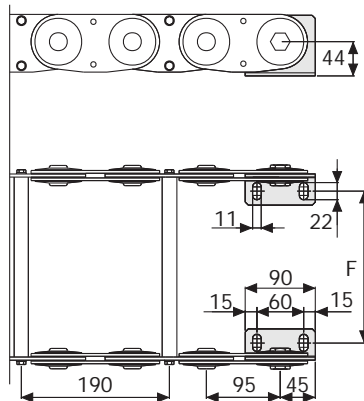

Fig. A
The chain can be fixed frontally, inner or outer radius. (Fig A)



Chain Type	F mm
BS3000NT106	88
BS3000NT156	138
BS3000NT206	188
BS3000NT256	238
BS3000NT306	288
Special dimension F=W-56	

Bright Zinc Plated Steel Type Part Numbers

Complete Set Assembled	
Chain Type	End Brackets Set
BS3000...	A3000NKM

Complete Set Unassembled	
Chain Type	End Brackets Set
BS3000...	A3000NK

Serie Steel

BS3000

Cable Chain
in Bright Zinc Plated Steel



Suitable to long travel distance.
See page 190



Supplementary movable separators.

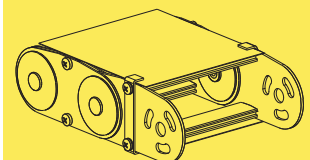

Steel laminar cover.

For further information please consult Brevetti Stendalto's Technical Office